

# **Fixed Frame Projection Screen**



**User Guide**

## INTRODUCTION



### WARNING - Sharp Edges

This product may contain sharp edges, please handle with care. Protective gloves are recommended.



### WARNING - Pinch Point

During assembly, keep hands clear between joining parts.



### WARNING - Heavy Object

Seek assistance in installing this product if necessary.

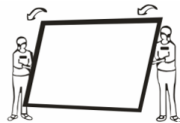

### WARNING - Do Not Touch

Avoid touching the optical surface or viewable area of the projection screen at all times.

## INTRODUCTION

### Table of Contents

Introduction	
Features	2
Getting Started	
Parts Included	3
Screen Material Handling	4
Projection Setup	4
Assembly	
Before You Start	5
Aluminum Frame	6
Screen Fabric	7
Installation	
Hanging Brackets	10
Maintenance Guide	
General Notes	11
Cleaning Guide	12
Troubleshooting	13

### Features

The Fixed Frame projection screen features include:

- **Elegant** and classy design with black velvet border.
- **Spring mount design** ensures an even distribution of stress across fabric to avoid wrinkles on the screen surface.
- **High strength aluminum frame** for long term durability.
- **Easy setup** by connecting the four corners and mounting the springs.

## GETTING STARTED

This guide will lead you through detailed steps on how to correctly and safely assemble and install your screen. Please follow the steps as instructed. If you need assistance, please see the Troubleshooting section.

### Parts Included

Check the parts and accessories inside the packaging to make sure none are missing.



① Aluminum Frame  
Horizontal x 4pcs



② Aluminum Frame  
Vertical x 2pcs

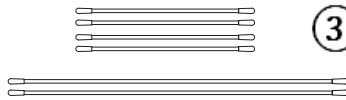

③ Fiber Glass Rod  
Long x 2pcs  
Short x 4pcs



④ Screen Fabric  
(with Floor Cloth)  
1 Roll

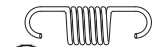

⑤ Spring  
(amount differs on size)

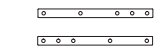

⑥ Frame Connector  
4pcs

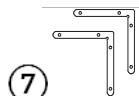

⑦ Corner Connector  
4pcs



⑧ Hanging Bracket  
(amount differs on size)



⑨ Hex Key  
(amount differs on size)



⑩ Hex Screws  
(amount differs on size)



⑪ Wall Screws  
and Expansion Plugs  
(amount differs on size)



⑫ Installation Hook  
(amount differs on size)

## GETTING STARTED

### Screen Material Handling

The projection screen material is a special engineered optical fabric for projection use only.

Do not use this screen material for other purposes.

Do not touch this screen material with your bare hands.

Do not fold the material or maneuver the material in other ways not described in this manual.

Do not use alcohol, abrasive, or other chemical cleaning solutions on the material.

Do not use any adhesive tape directly on the material.

Do not use any tools or sharp objects against the screen material.

Do not press the screen material against any hard surfaces.

We will not be responsible for any damage to the screen caused by false handling.



### Projection Setup

The fixed frame projection screen is designed for front projection. Make sure you are using the correct projection method. The screen material is an ambient light rejecting material with angular reflective properties. For best performance, angle the projector so the reflection angle lines up with the view as shown in the diagram below.

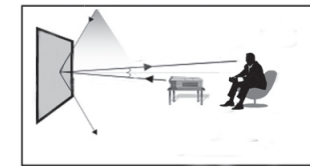
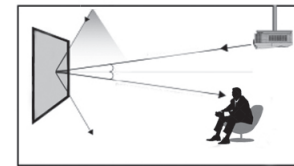

The distance required between the projection screen and the projector depends on your projector. Please refer to your projector's manual or technical specifications for more details.

We recommend the projector be mounted onto the ceiling and the screen against a flat wall.

## ASSEMBLY

You are now ready to assemble your screen. There are 2 parts of the screen that need to be assembled: the Aluminum Frame and the Screen Fabric. Please go through the following steps carefully.

### Before You Start

You will be assembling the screen on a flat ground. You will need a clearance area of at least two feet away from the screen. Make sure no objects are underneath the screen as they may cause permanent damage to the fabric.



Before you start handling parts, you need to make sure your work area is safe, and remains safe during assembly and installation. Please note and be aware of the following:



#### Parts may contain sharp edges.

Avoid touching the indicated spots. Do not swing the aluminum frames; be aware of the edges when you handle the frames. Protective gloves are recommended.



#### Beware of pinching point.

Be cautious joining pieces together when this icon is present. Keep body parts away from the indicated spots. Protective gloves are recommended.



#### Special attention needed.

Please refer to the description whenever this icon is present. Detailed instructions are in the description which are not present in the diagram.

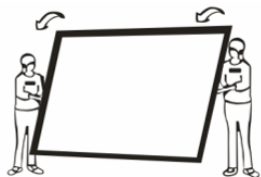

Assembling the screen requires two people. We recommend you and your partner to work together to assemble the screen. Seek assistance when handling heavy objects or hanging the screen. Careless operations can cause injuries and permanent damage to parts.

## ASSEMBLY

### Aluminum Frame

1. Slide two frame connectors (6) into the slots on the flat side of the horizontal frame pieces (1). Connect the frame pieces by sliding the frame pieces together. Tighten the hex screws (10) with the hex key (9) after the frame pieces are aligned and the gap between them is less than 1mm.

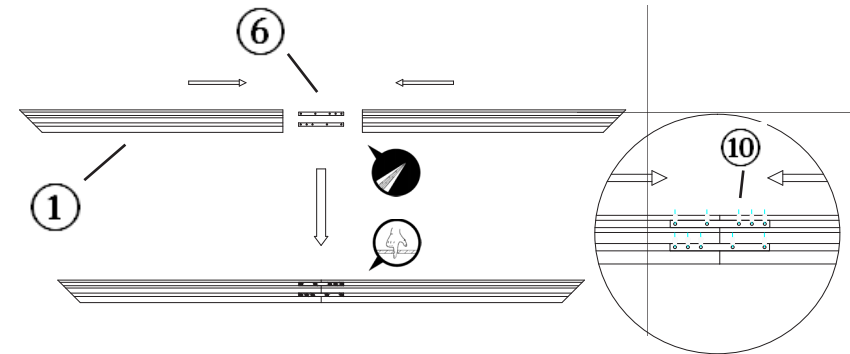

If the gap between the frame pieces on the back exceeds 1mm, loosen the hex screws and repeat the step above after pushing the frame pieces together more than was previously applied.

2. Slide two corner connectors (7) into the channels in the vertical frame pieces (2) as shown below left. Slide the vertical and horizontal frame pieces together as shown below right. Align the corners and make the gap between them less than 1mm. Do not tighten the hex screws.

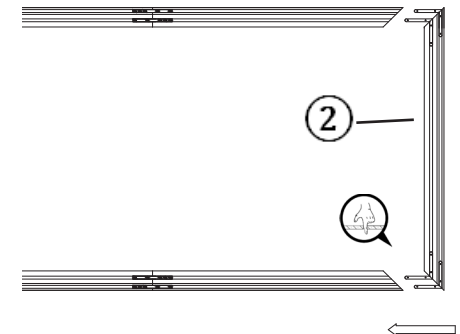
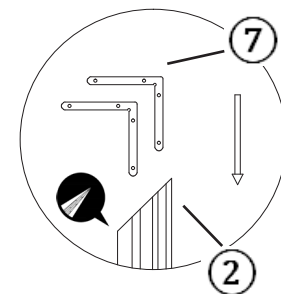

## ASSEMBLY

- After the corners are in place, start from one corner and tighten the hex screws. Make sure that the corners are still aligned properly when tightening the hex screws. Repeat with the other 3 corners.

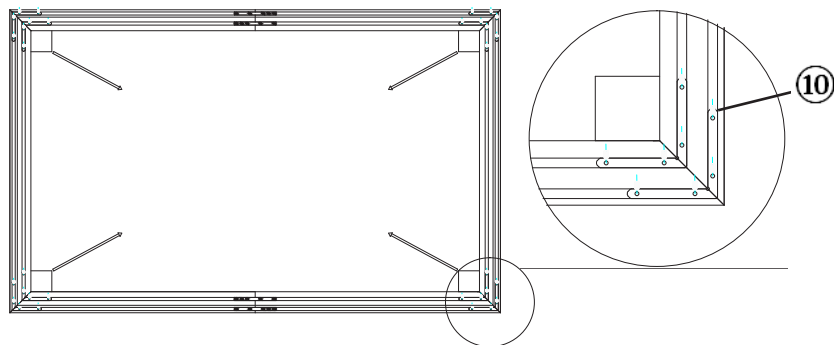

After the frame is assembled, check the front of the frame to ensure the horizontal joints are straight and the corners are at 90° angles without gaps. Adjust if necessary by repeating the steps above and applying more force while tightening the hex screws so it is locked in the correct position.

## Screen Fabric

Slowly unroll the screen fabric from the cardboard drum onto the assembled frame with the front of the fabric (white side) facing the ground and its back (black side) facing upwards.

If you need to flip the fabric, **DO NOT FOLD** the fabric, as it will cause permanent damage. If the fabric is being unrolled on the ground, use the provided floor cloth to protect the screen fabric against dirt or damage from the ground.

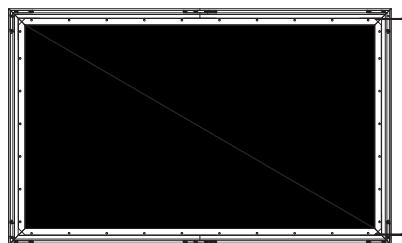

## ASSEMBLY

- Insert the fiber glass rods (3) into the sleeves on the four sides of the fabric as shown below.

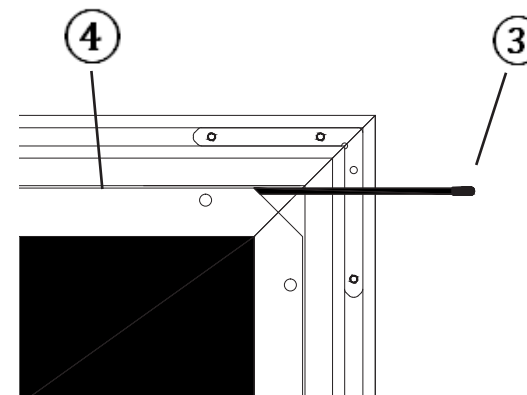

The longer, horizontal side will require two shorter rods. Insert the two rods from opposite sides. Make sure the rods are all the way in and properly centered.

- Using the installation hook (12), mount the springs between the holes in the fabric sleeve and the connection slot as shown below. The installation hook should only be pulling on the fiber glass rod and not on the screen material as this will cause permanent damage.



Check and make sure there are no objects inside the Connection Slot.



Mount one side of the spring on the frame first, then mount the other end on the fabric as shown on the right.

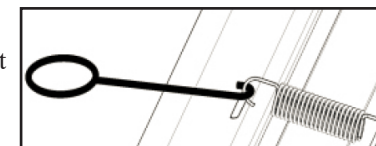

## ASSEMBLY

6. The fabric and the frame will be joined with springs. First the corners will be secured, then the sides will be secured starting from the corners and moving towards the middle. The shorter sides should be secured first for optimal tension. The priority in which the springs should be secured is shown below.

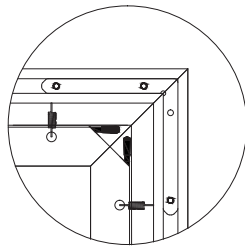
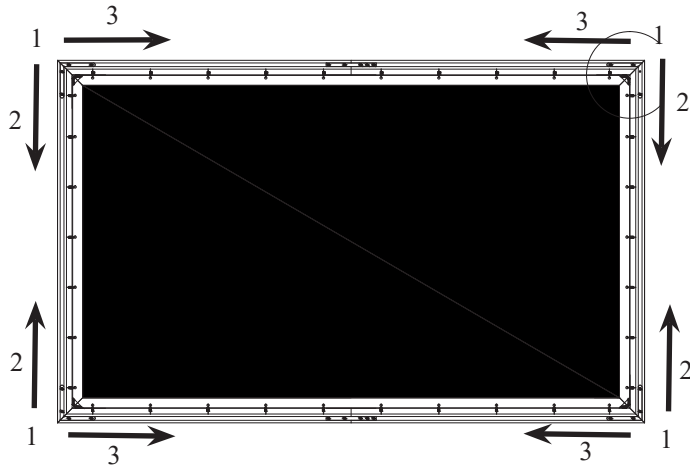

If the screen material is white on both sides or an acoustic woven material, a black backing and additional springs for mounting are provided. To install the black backing, repeat steps 5-6. The black backing will go onto the frame the same way as the projection fabric. The fuzzy side of the black backing will face the front of the screen. Make sure the springs do not touch each other.

## INSTALLATION

You are now ready to mount your screen. Please make sure your screen is fully assembled.

### Hanging Brackets

7. Decide where the screen will be mounted and where the four sides of the screen will be. Please refer to the diagram below.

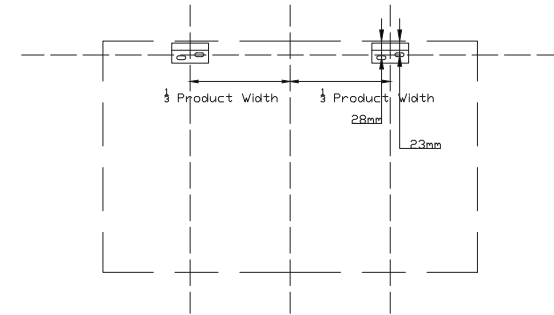

As shown above, draw a center line for your screen. Mount the Hanging Brackets one third of the screen width from the center line. Two holes must be drilled for each bracket. The upper hole should be 23mm from the top of the screen and the lower hole should be 28mm below the top border.



As shown on the right, each Hanging Bracket has two slots 4mm apart from each other vertically, from center to center.

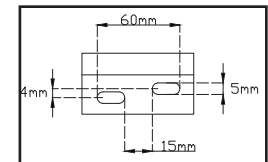

8. Lift the screen onto its brackets as shown below.

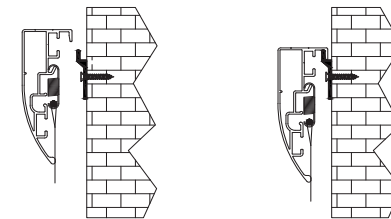

Please make sure the wall you are mounting your screen to is able to support the weight of the screen. We recommend using your own hardware for the installation. If using the hardware supplied, (Wall Screws and Expansion Plugs) ensure that it is compatible with the wall.

## MAINTENANCE GUIDE

### General Notes

Please handle the screen with care to keep it in good condition for many years to come.

1. Do not touch the fabric surface by hand or with hard objects. Doing so may cause scratches on the projection material.
2. Do not fold the screen fabric. This will cause there to be creases in the material.
3. Do not scratch or write on the screen.
4. Do not put sharp objects on or underneath the screen during assembly or maintenance. This can damage the screen material.
5. Do not attempt to assemble or disassemble using methods not mentioned in this guide.
6. Do not clean the screen fabric with corrosive or abrasive detergent.
7. When mounting and dismounting the screen, 2 people are needed. Do not stand underneath the screen when it is being mounted or hanging.
8. Keep any spare parts and this instruction manual where they can be accessed if needed. Keep out of reach of small children.
9. Make sure the mounting hardware is strong enough to support the weight of the screen and is suitable for the wall it is being installed on.

## MAINTENANCE GUIDE

### Cleaning Guide

For cleaning dirt and dust off the fabric, we recommend using a soft damp cloth. For tougher stains, use a soft brush and water to clean the screen. Be very careful when cleaning the screen material so it does not become damaged and worsen the viewing image.

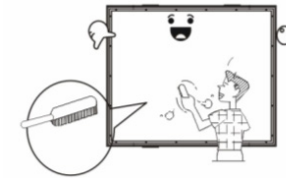

Do not use any corrosive or abrasive materials to clean the screen as this can damage the screen. Proper screen care and maintenance will keep your projection image looking exactly as intended.

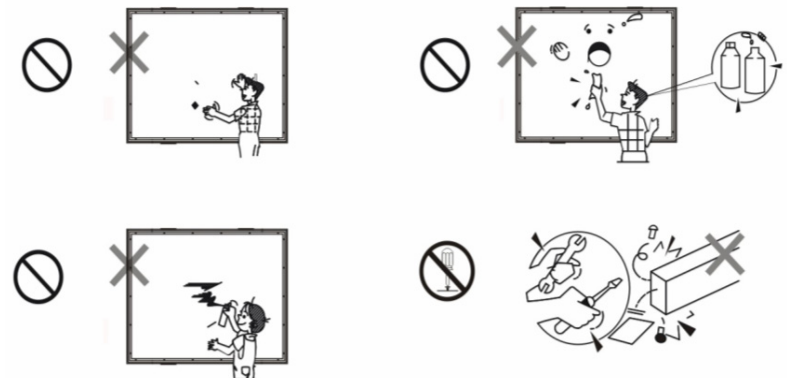

## TROUBLESHOOTING

1. *I am missing parts from my packaging.*

**Solution:** The Fiber Glass Rods may be stored inside the roll of Screen Fabric. Check if your missing parts are already pre-installed onto the screen. If you still have parts missing, contact customer support.

2. *My screen fabric is damaged when I open the package.*

**Solution:** In case of damaged or defective product, please contact your vendor or customer support right away.

3. *It is very difficult to pull the springs.*

**Solution:** Make sure you are using the correct methods. Seek assistance if needed, careless operation may risk damaging the screen.

5. *I see wrinkles and lines on the screen projection surface.*

**Solution:** If you just installed this screen, and you see lines or wrinkles on the screen surface, do not panic! The screen material is a flexible projection material and depending on how the screen material is handled or installed, the screen may have wrinkles. With proper adjustments they will disappear.

Check the tension of the screen material, and smooth out the material evenly along the side of the Fiber Glass Rod holding the screen. Make sure there is sufficient tension on the screen. If done properly, you should have very few to no wrinkles on the screen. Consider leaving your screen in a warm environment for up to few weeks which will allow the fabric to relax and flatten itself overtime. Install the screen on the wall properly before doing so; do not lean the screen against other objects or leaving it on the ground. If you still have wrinkles over a few weeks or if you have any concerns, consider contact customer support.

## TROUBLESHOOTING

6. *There is a gap in the frame that is visible from the front.*

**Solution:** The frame pieces most likely moved while tightening the hex screws on the frame connectors or corner connectors. Loosen the hex screws at the joint where a gap is present and push the two frame pieces together so there is no gap. Tighten the hex screws to secure in place.

7. *I can see through the screen material.*

**Solution:** The black cloth was not installed after the screen material was mounted. Install the black backing in the same way as the screen material. See step 6 for further instructions.



